

# HOUTTUIN 231 SERIES PUMPS

## SELF-PRIMING VERTICAL SCREW PUMP FOR NON LUBRICATING LIQUIDS

### PRODUCT PERFORMANCE YOU CAN RELY ON

The Houttuin double entry twin screw pumps series 231 are vertical rotating self priming positive displacement pumps. Two intermeshing screws rotating in a pump casing insert ensure high pumping efficiency with constant axial flow and unequalled suction power.

- Rugged design for the harshest environments
- Field replaceable liner and 'pop-out' rotor access for ease of inspection and maintenance
- Vertical design with space-saving bracket for motor mounting



### 231 SERIES VERTICAL SCREW PUMP

Up to 300 m<sup>3</sup>/hr, 16 barg and viscosities from 0.6 cSt

## PRODUCT SPECIFICATIONS AND FEATURES

Casing and Covers	Ductile iron, cast iron, carbon or stainless steel (type 300 or 400)
Rotors	Carbon or stainless steel (type 300 or 400) (with optional hardening and plating)
Liner	Ductile iron, cast iron, ni-resist, bronze (with optional hardening and plating)
O-rings	Buna N, viton steel or teflon (in contact with pumped fluid), nitrile (in contact with lubricating oil)
Shaft Sealing	Stuffing boxes, lip seals, single or double mechanical seals
Timing Gears	Spur or double helical
Bearings	Roller - internal or external
Flow rate range	Up to 300 m <sup>3</sup> /hr (2,000 gpm)
Outlet pressure	Up to 16 barg (232 psig)
Inlet pressure	Up to 10 barg (145 psig)
Viscosity	0.6 - 1,500 cSt
Temperature	-5° C to 100° C (-20° f - 284° F)
Speed	Up to 2900 rpms
Drive	Direct, suitable for variable speed operations
Rotation	Clockwise facing pump driveshaft
Mounting	Horizontal
Port Connections	Per ANSI 150#, 300#, 600# or DIN PN16, PN24 – locations: top, bottom, right, left
Accessories	Pressure relief valve, temperature and vibration monitors

# PERFORMANCE GRAPHS

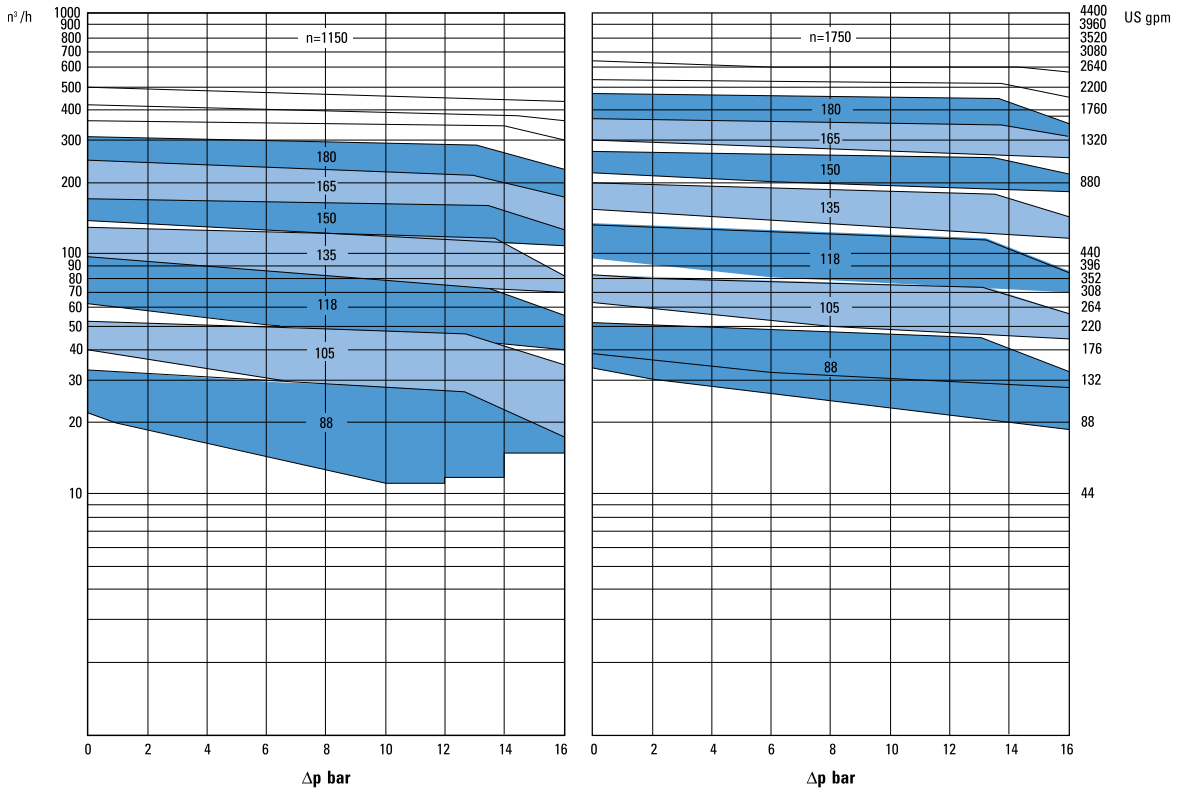
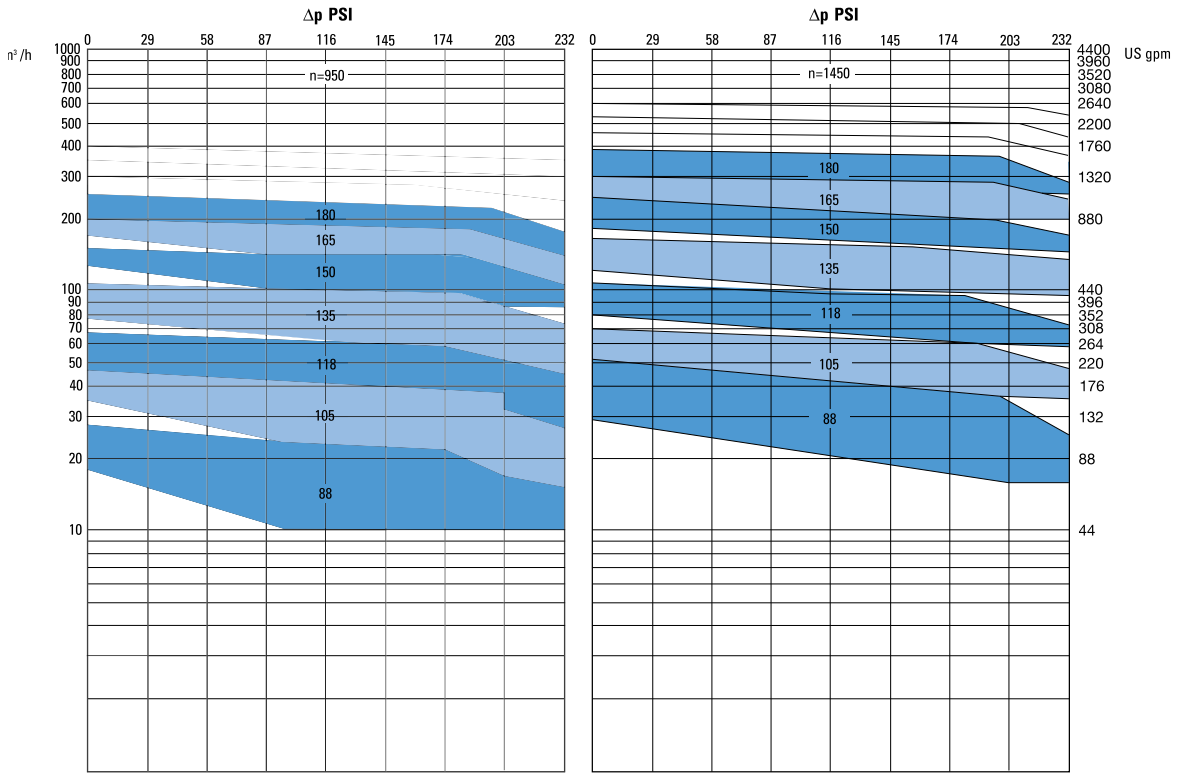

# HOUTTUIN 231 DIAGRAM

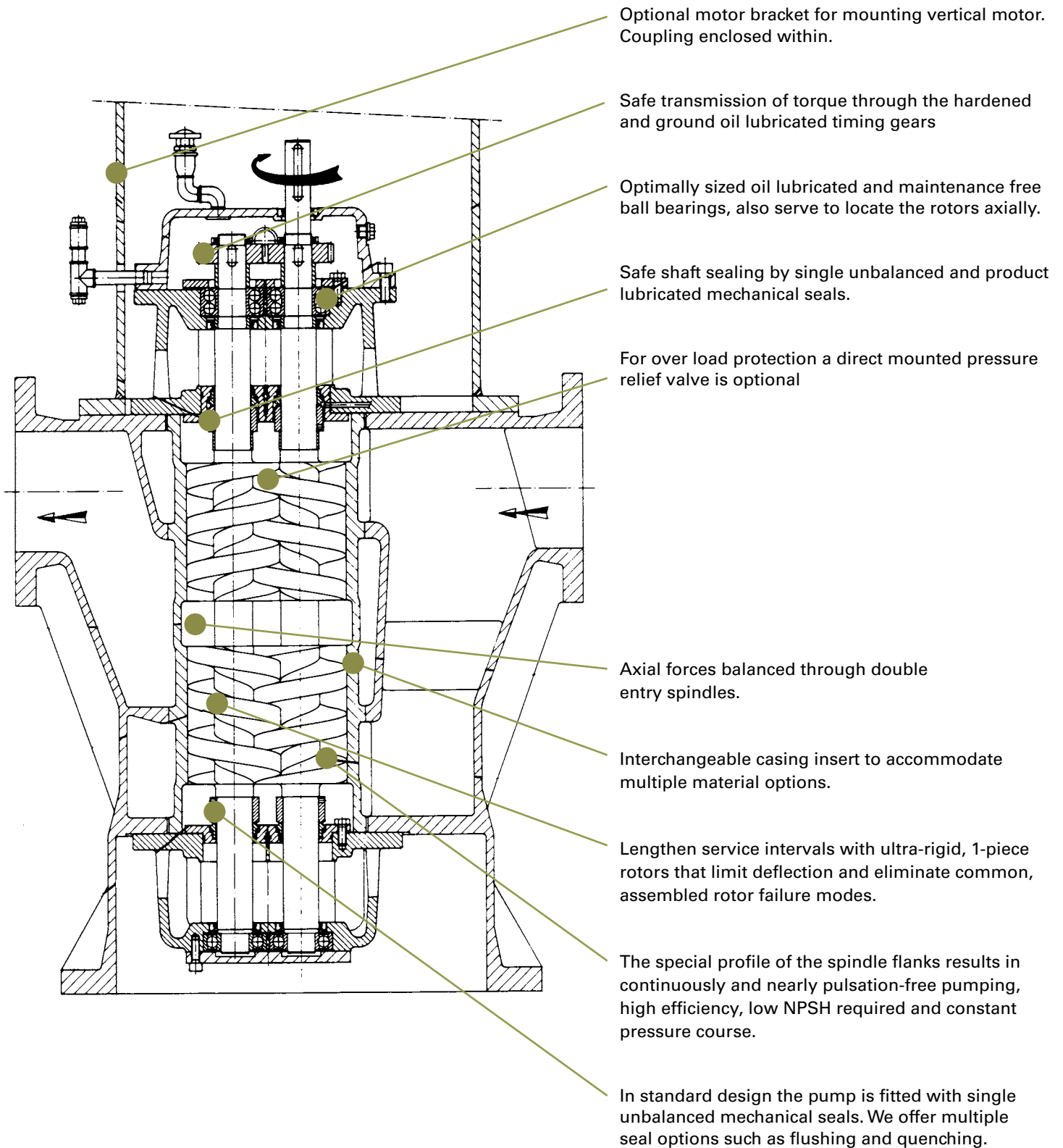

# DIMENSIONS

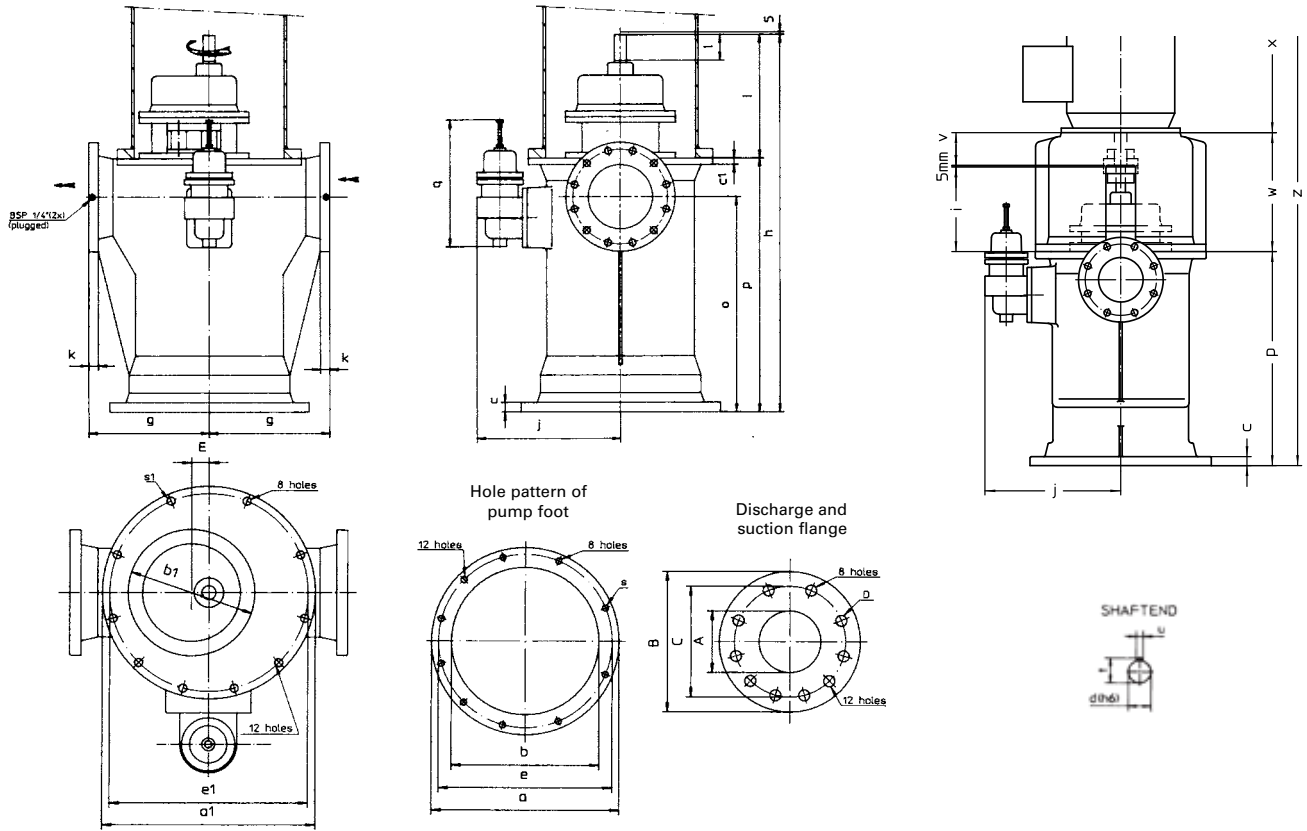

PUMP SIZE	FLANGES PN16 DIN 2533					PUMP FOOT					PUMP UPSIDE					MOTOR		
	A	B	C	D	E	A	B	C	E	S	A1	B1	C1	E1	S1	KW	RPM	FRAME
88	100	228	180	8x18	32.5	500	380	26	460	8x18	450	277	22	420	8xm12	22	1480	180L
105	125	254	210	8x18	37.5	530	400	30	490	8x18	490	290	22	450	8xm16	37	1480	225S
118	150	285	240	8x22	42	610	470	30	560	8x22	575	340	24	535	8xm16	55	1480	250M
135	200	343	295	12x22	47	620	475	30	570	8x22	575	340	25	535	8xm16	90	1480	280M
150	250	405	355	12x26	52.5	660	510	30	610	12x22	620	390	28	580	8xm16	110	1480	315S
165	250	405	355	12x26	57.5	700	550	30	650	12x22	660	415	30	620	12xm16	160	1480	315M
180	300	460	410	12x26	63	750	600	30	700	12x22	720	452	30	670	12xm16	200	1480	315L

PUMP SIZE	PUMP DIMENSIONS												SHAFT END				RELIEF VALVE SIZE	WEIGHT KG (CA)
	G	H	I	J	K	O	P	Q	V	W	X	Z	D	L	T	U		
88	300	932	310	362	24	555	622	270	110	425	590	1637	28	60	31	8	46	295
105	330	992.5	322.5	382	26	590	670	270	140	467.5	697.5	1835	28	60	31	8	46	310
118	360	1060	340	460	26	625	720	397	140	485	735	1940	32	80	35	10	70	380
135	375	1140	350	535	30	670	790	397	140	495	920	2205	38	80	41	10	70	405
150	395	1300	400	568	32	750	900	540	170	575	955	2430	42	110	45	12	100	515
165	420	1409	429	588	32	830	980	540	170	604	1055	2639	45	110	48.5	14	100	660
180	450	1492	445	615	32	875	1047	735	170	620	1125	2792	50	110	53.5	14	135	895

Dimensions in mm, dimensions are subject to alternations.

# PERFORMANCE DIAGRAMS TOTAL PUMP PROGRAM

## STANDARD PUMPS

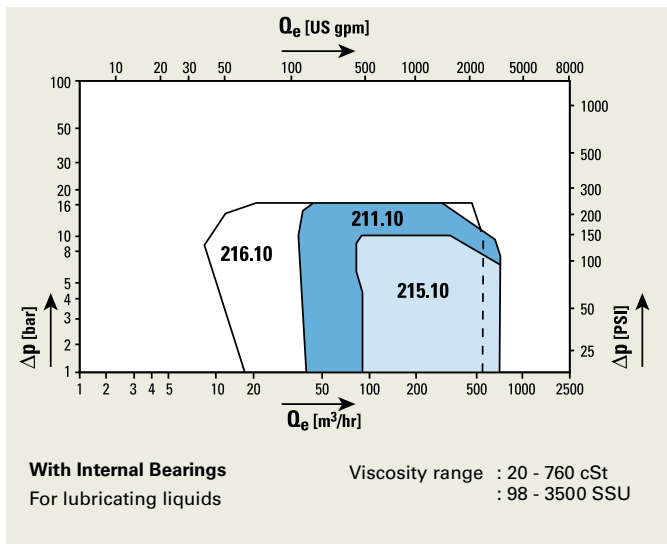

## STANDARD PUMPS

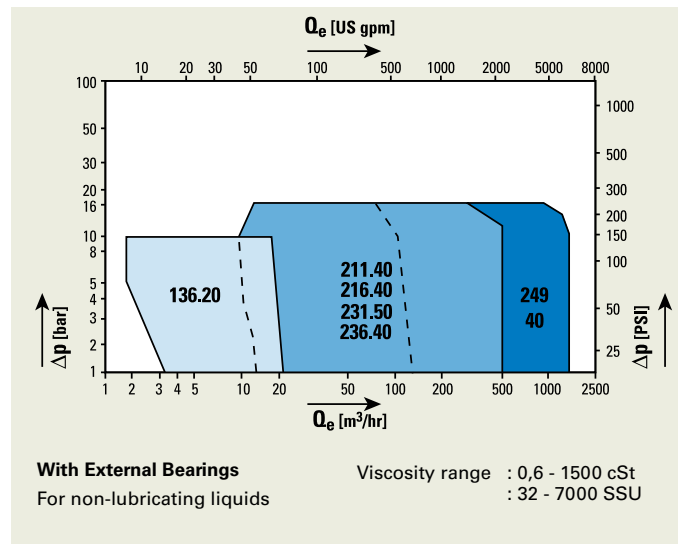

## STANDARD PUMPS

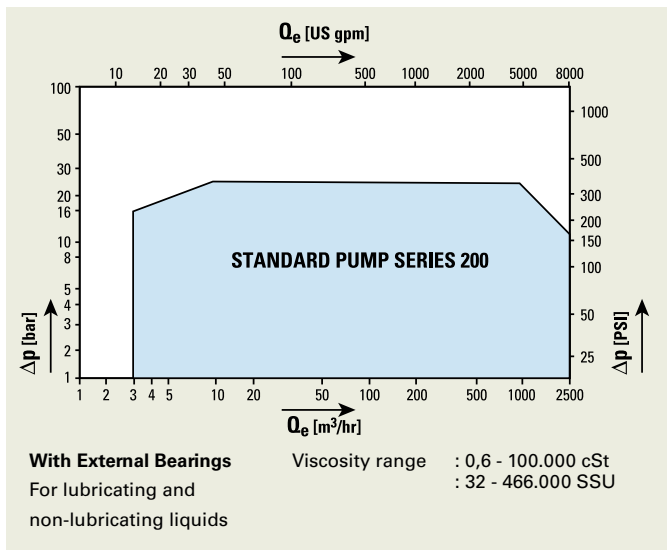

## ENGINEERED PUMPS

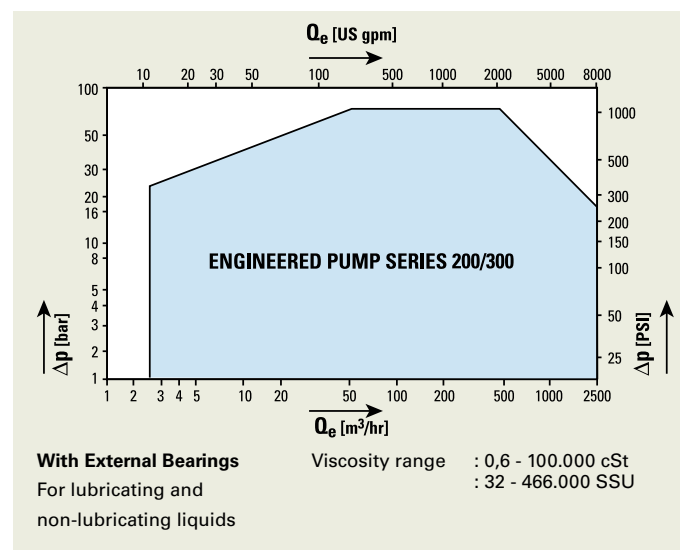

**CIRCOR**

1710 Airport Road  
Monroe, NC 28110-5020  
Tel: +1.704.289.6511  
Tol: +1.877.853.7867

Oil & Gas Products & Services

ALLWEILER® HOUTTUIN™ IMO® ROSSCOR® WARREN®

CIRCOR, ALLWEILER, HOUTTUIN, IMO, ROSSCOR, and WARREN are registered trademarks of the CIRCOR or its subsidiaries in the U.S. and/or other countries. © 2018 CIRCOR International. All rights reserved.  
GB-OG020-HT231-03/18



HOUTTUIN™